

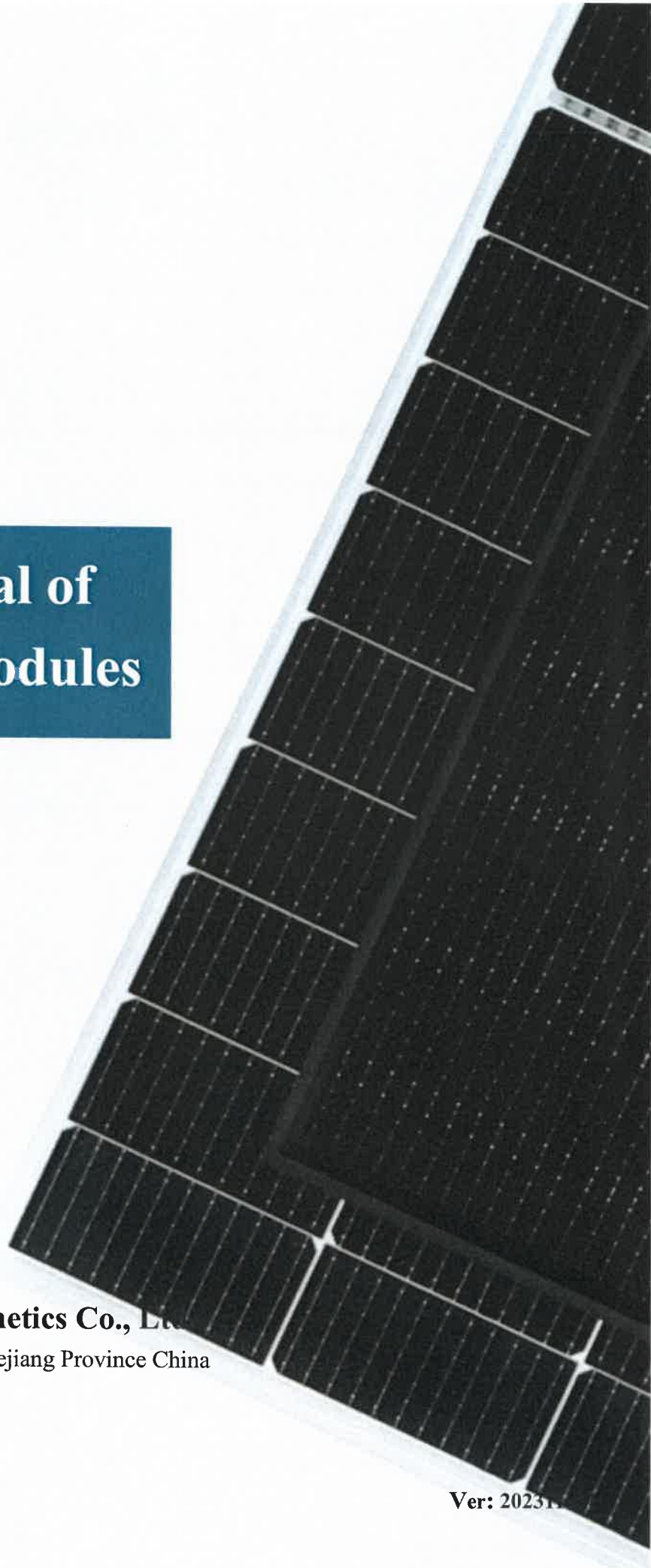

# Installation Manual of Standard Solar Modules

**Hengdian Group DMEGC Magnetics Co., Ltd.**  
Hengdian Industrial Area, Dongyang City, Zhejiang Province China  
Tel: +86-579-86310330  
E-mail: [service@dmegc.com.cn](mailto:service@dmegc.com.cn)

Ver: 202311



# Contents



1. General Information	2
1.1 Installation Manual Disclaimer	3
1.2 Limitation of Liability	3
2. Safety Precautions	3
2.1 General Safety	3
2.2 Safety guidelines for handling modules	3
2.3 Safety guidelines during installation	4
3. Electrical installation	4
3.1 Electrical installation	5
3.2 Unpackaging and storage	5
4. Mechanical Installation	6
4.1 Precautionary Measures and General Safety	6
4.2 Environmental Conditions	6
4.3 Installation Requirements	6
4.4 Optimum Orientation and Tilt	7
4.5 Avoid Shading	7
4.6 Reliable Ventilation	7
4.7 Module Wiring	7
4.8 Grounding	9
5. Mounting Instructions	9
5.1 Mounting Method: Bolting	10
5.2 Mounting Method: Clamping	10
5.3 Assembly variants	11
6. Maintenance	17
7. Module Cleaning Guidelines	18
8. Disposal	19
Annex	20

## 1. General Information

Congratulations, with DMEGC Solar photovoltaic modules,

[www.dmegcsolar.com](http://www.dmegcsolar.com)

you have purchased a high-quality product. This installation manual contains important information on safety, installation

and operation of the modules, which you need to read thoroughly and carefully and take note of all instructions before installing, wiring, operating, servicing or transporting the modules.

All safety information and mounting instructions in this installation guide must read carefully and have to be fulfilled. The photovoltaic modules must be installed and operated in accordance with the generally recognized technical regulations. During assembly, the relevant national guidelines on health and safety and accident prevention must be observed and adhered to. This particularly applies to work on the roof. Please observe all local, regional, national and international legal provisions, guidelines, standards and regulations, as well as the guidelines on work safety from the employer's liability insurance associations. Failure to follow these instructions may result in property damage, injury or even danger to death. Assembly, installation and initial operation can only be carried out by licensed and qualified professionals. Appropriate safety measures (e.g. fall protection devices) must be used for work, particularly on roofs. The installers must inform end-users (consumers) the aforesaid information accordingly. The word "module" or "PV module" used in this manual refers to one or more standard solar modules of DMEGC Solar which are listed in the document.

### 1.1 Installation Manual Disclaimer

The information contained in this manual is subject to change by DMEGC Solar without prior notice. DMEGC Solar gives no warranty of any kind whatsoever, either explicitly or implicitly, with respect to the information contained herein. In the event of any inconsistency among different language versions of this document, the English version shall prevail. Please refer to our product lists and documents published on our website at: [www.dmegcsolar.com](http://www.dmegcsolar.com) as these lists are updated on a regular basis.

### 1.2 Limitation of Liability

DMEGC Solar shall not be held responsible for damages of any kind, including – without limitation – bodily harm, injury or damage to property, in connection with handling PV modules, system installation, or non-compliance with the instructions set forth in this manual.

## 2. Safety Precautions



### Warning

Before attempting to install, wire, operate and/or service the module and other electrical equipment, all instructions should be read and understood. PV module connectors pass direct current (DC) when exposed to sunlight or other light sources. Contact with electrically active parts of the module,

such as terminals, can result in injury or death, irrespective of whether or not the module and the other electrical equipment have been connected.

### 2.1 General Safety

- The safety requirements are in accordance with IEC/UL 61730 and all DMEGC Solar photovoltaic modules are certified in accordance with IEC/UL 61215 and IEC/UL 61730 (protection class II).
- Please observe all regulations and guidelines under public law during planning, erection, operation and maintenance of grid-connected PV plants including the following: national standards, technical connection conditions, accident prevention regulations, the relevant valid guidelines from the association of property insurers and all other relevant general guidelines.
- Before installing modules, please consult local laws and regulations to comply with their requirements for building fire resistance. According to the corresponding certification standards, DMEGC's Mono-facial glass modules have a fire rating of UL Type 1 or IEC Class C, while double glass modules have a fire rating of UL Type 29 or IEC Class C.
- When installing on the roof, it is necessary to cover the roof with a layer of fireproof material suitable for that level, and ensure sufficient ventilation between the back panel and the installation surface. The different structures and installation methods of the roof can affect the fire safety performance of the building. If installed improperly, it may lead to a fire.
- To ensure the fire rating of the roof, the minimum distance between the frame and the roof surface is 100 mm.
- Please use appropriate module accessories such as fuses, circuit breakers, and grounding connectors according to local regulations.
- Do not install modules if exposed flammable gases are present nearby.

### 2.2 Safety guidelines for handling modules

- Handle the modules with care to prevent damage, in particular, do not tread on the module. Do not let it drop and protect it from falling objects.
- Solar modules must not be kept or transported on the connection cable or socket.
- Do not damage or scratch the back of the modules and do not set a module down heavily on a surface. Take particular care when the module is on an edge.
- Wear gloves and personal protective equipment (PPE) which include but not limited to fall protection, ladder

or stair and personal protective measures.

- Do not stack the modules on top of one another to avoid damage.
- Never leave the modules unsecured or without a bracket.
- Contact with module surfaces or frames may cause electric shock if the front glass is broken or the backsheets is torn.

### 2.3 Safety guidelines during installation

- The entire PV system must be mounted according to the generally recognized technical regulations by licensed electricians in accordance to the applicable electrical codes such as, the latest National Electrical Code or other national or international applicable electrical codes.
- Do not install or handle modules in unsafe conditions including but not limited to strong winds or gust, sandy roofs.
- Do not allow children or unauthorized persons near the installation site or module storage area.
- Do not disassemble, change or adapt the module or remove any DMEGC Solar fitted part or nameplate, otherwise guarantee claims will become invalid.
- Do not use or install damaged modules.
- Do not artificially concentrate sunlight on a module.
- Do not connect or disconnect modules when current from the modules or an external source is present.
- The PV module does not contain any serviceable parts. Do not attempt to repair any part of the module.
- Keep the junction box cover closed at all times.
- Prior to installation, remove all metallic jewelry to prevent accidental exposure to live circuits.
- Never interrupt electrical connections or pull-out connectors while the circuit is live.
- Only use insulated tools and wear rubber gloves that are recommended for electrical installation work.
- During installation and while the module is exposed to light, avoid touching the electric terminals or cable ends.
- The solar modules, particularly the connectors and tools, must be dry during installation.
- Avoid loading the module cable mechanically, covering drainage holes or allowing water to run in the direction of the plug connectors.
- Disconnecting from direct current conductors can cause electric arcs. It is therefore essential that you disconnect the inverter from the alternating voltage grid before the start of any work on photovoltaic systems, particularly before disconnecting connectors in direct current circuits.

- Solar modules can only be taken out of operation by removing light irradiation. To do this, the front surface has to be covered e.g.: with a towel, box or other fully opaque material or turn the front surface downwards on a smooth, flat surface.
- Do not use the modules close to devices or areas where gas is produced or can accumulate.
- Do not install solar modules close to highly flammable substances or vapors (solar modules are not explosion-protected equipment).
- If the disconnects and overcurrent protection devices cannot be opened or the inverter cannot be powered down, cover the fronts of the modules in the PV array with an opaque material to stop the production of electricity when installing or working on a module or wiring.
- When installing modules in light rain, morning dew, take appropriate measures to prevent water ingress into the connector.
- Not allowed to use modules on mobile products of any kinds like cars, trucks, boats or buoys. They are intended to operate solely in open air and on solid ground.
- If modules are used as balcony modules, local norm regulations must be followed. For German market, German DiBT with abz for overhead installations can't be provided. The installer shall bear the safety risks and losses caused by the module being not firmly fixed.
- Observe all safety measures and instructions for other components used.
- Fire protection guidelines and requirements for houses and buildings from the local authorities must be considered.
- If necessary, please take suitable lightning protection measures in accordance with country-specific standards and regulations.
- If there is a lightning protection system at the building already existing, then the module frame and the mounting system must be integrated into the external lightning protection and if necessary, surge protection devices should also be installed. Please get in touch with a lightning protection specialist for this.

## 3. Electrical installation

### Product Identification

- Each module has two or three identical barcodes (one in the laminate under the front glass, the second on the rear side of the module and the third on the long side

frame) that act as a unique identifier.

- A nameplate is also affixed to the rear of each module. This nameplate specifies the model type, as well as the main electrical and safety characteristics of the module.

**3.1 Electrical installation**

- Take all necessary precautions during installation, operation and servicing of the modules to avoid electrical hazards.
- All electrical connections must be securely closed.
- Contact with a direct voltage of 30 V is dangerous, electrical shock or burn can occur, any contact above those voltages can be fatal.
- If the direct voltage of the entire system exceeds 100 V, the installation, operation and maintenance must be performed by a licensed electrician, unless the local regulations for handling electrical systems specify otherwise.
- Module electrical ratings are measured under Standard Test Conditions (STC) of 1000 W/m<sup>2</sup> irradiance, with an AM1.5 spectrum, and a cell temperature of 25°C and marked on nameplate.
- Detailed electrical characteristics of DMEGC Solar modules can be found in module datasheets on [www.dmegcsolar.com](http://www.dmegcsolar.com).
- The maximum open circuit voltage of the system must not exceed the maximum system voltage of the module.
- The maximum reverse current resistance of the module has must be followed. Certified adequate overcurrent blocking devices (fuse or current interruption) should be used depending on the safety values.
- As a manufacturer, Stäubli guarantees interconnectivity and pluggability within the Stäubli Multi-Contact® connector family taking into account the system voltage up to 1000 V. They also guarantee interconnectivity and pluggability for the Stäubli Multi-Contact® connector EVO2 and EVO2A. Due to the gap of technical performances between MC4 connectors and MC4-Evo2A connectors, only the lower technical parameters from both connectors, such as the rated voltage and the rated current, are available in case of cross-connection. Please note that Staubli does not recognize a compatibility between Staubli PV-connectors and the connectors from other manufactures.
- During system cabling, please pay attention to the correct cross-sections and connections permitted for the maximum short-circuit current intensity of the module. The cable must have a minimum cross-section of 4mm<sup>2</sup> and the isolation must be permitted for the maximum

system voltage.

- During assembly, beware of tensile force relief on the module connection cable.
- The socket, cable and connector must not be moistened or cleaned with oily, greasy or alcohol-based substances.
- The DMEGC modules are fitted with pre-installed bypass diodes ex-works, which are inside the socket.
- Under certain conditions, a module may produce more current or voltage than its Standard Test Conditions rated power. As a result, the module short-circuit current under STC should be multiplied by 1.25, and a correction factor should be applied to the open-circuit voltage (see Table 1), when determining component ratings and capacities. Depending on your local regulations, an additional 1.25 multiplier for the short-circuit current (giving a total multiplier of 1.56) may be applicable when sizing conductors and fuses.

Table 1: Low temperature correction factors for open-circuit voltage

Lowest Expected Ambient Temperature (°C/°F)	Correction Factor
24 to 20 / 76 to 68	1.02
19 to 15 / 67 to 59	1.04
14 to 10 / 58 to 50	1.06
9 to 5 / 49 to 41	1.08
4 to 0 / 40 to 32	1.10
-1 to -5 / 31 to 23	1.12
-6 to -10 / 22 to 14	1.14
-11 to -15 / 13 to 5	1.16
-16 to -20 / 4 to -4	1.18
-21 to -25 / -5 to -13	1.20
-26 to -30 / -14 to -22	1.21
-31 to -35 / -23 to -31	1.23
-36 to -40 / -32 to -40	1.25

Alternatively, a more accurate correction factor for the open-circuit voltage can be calculated using the following formula:

$$C_{Voc} = 1 - \alpha_{Voc} \times (25 - T)$$

T (°C) is the lowest expected ambient temperature at the system installation site.

$\alpha_{Voc}$  (%/°C) is the voltage temperature coefficient of the selected module (refer to corresponding datasheet).

Electrical calculations and design must be performed by a competent engineer or consultant.

Please contact DMEGC Solar's technical support team for additional information pertaining to engineering optimization and approval of project specific module string lengths.

**3.2 Unpacking and storage**

Precautions

- Modules should be stored in a dry and if necessary ventilated environment to avoid direct sunlight and

moisture.

- Unloading and unpacking instructions have to followed.
- Modules must always be unpacked and installed at least by two people and handled at the frame parts.
- The bending radius of the cable must be at least five times of the outside cable diameter.
- Do not stand, step, walk and/or jump or drop objects on modules under any circumstances. Localized heavy loads may cause severe micro-cracks at cell level, which in turn may compromise module reliability and void DMEGC Solar’s warranty.
- Do not leave the module backsheet directly in contact with the support structure underneath when handling or installing the module.
- Do not use sharp instruments on the modules.
- Do not expose the modules and its electrical contacts to any unauthorized chemical substance (e.g., oil, lubricant, pesticide, etc.).
- Do not leave modules unsupported or unsecured.
- Do not change the wiring of bypass diodes.
- Keep all electrical contacts clean and dry at all times.

## 4. Mechanical Installation

### 4.1 Precautionary Measures and General Safety

- Prior to installing modules, please obtain information about any requirements and necessary approvals for the site, installation and inspection from the relevant authorities.
- Check applicable building codes to ensure that the construction or structure (roof, facade, support, etc.) can bear the module system load.
- DMEGC Solar’s standard modules have been qualified for Application Class A (equivalent to Safety Class II requirements). Modules rated under this class should be used in systems operating at voltage above 50V or power above 240W, where general contact access is anticipated.
- Consult your local authority for guidelines and requirements for building or structural fire safety. When installing modules, ensure the assembly is mounted over a fire-resistant roof covering rated for the application.
- The fire rating is only valid when the product is installed as specified in the mechanical mounting instructions.

### 4.2 Environmental Conditions

- PV modules are intended for use in general open-air climates, as defined in IEC 60721-2-1: Classification of environmental conditions Part 2-1: Environmental

conditions appearing in nature—Temperature and humidity.

- It is recommended to install the modules in an environment with a working environment temperature of -40 °C to 40 °C, which is the monthly average highest and lowest temperature at the installation location. The maximum working environment temperature of the component is -40 °C to 85 °C.
- Please consult the DMEGC Solar’s technical support department for more information on the use of modules in special climates, such as an altitude greater than 2000m.
- Do not install modules near open flames or flammable materials.
- Do not immerse modules in water or constantly expose modules to water (either fresh or salt, i.e., from fountains, sea spray).
- Exposing modules to salt (i.e., marine environments) or sulfur (i.e., sulfur sources, volcanoes) incurs the risk of module corrosion.

**NOTICE** DMEGC modules passed the IEC 61701 salt spray corrosion test evidence available on request, but the corrosion may still occur where the modules frame is connected to the bracket or where the grounding is connected. DMEGC modules can be installed  $\geq 50$  m away from the ocean side, and related parts and components should be protected with anti-corrosion measures.

### 4.3 Installation Requirements

- Ensure that the module meets the general technical system requirements.
- Ensure that other systems components do not damage the module mechanically or electrically.
- Modules can be wired in series to increase voltage or in parallel to increase current. To connect modules in series, connect the cables from the positive terminal of one module to the negative terminal of the next module. To connect in parallel, connect the cables from the positive terminal of one module to the positive terminal on the next module.
- The quantity of bypass diodes in the module’s junction box provided may vary depending on the model series.
- Only connect the quantity of modules that corresponds to the voltage specifications of the inverters used in the system. In addition, modules must not be connected together to create a voltage higher than the maximum permitted system voltage stated on the module nameplate, even under the worst local temperature conditions (see table 1 for the correction coefficients

that apply to open-circuit voltage).

- A maximum of two strings can be connected in parallel without using an over-current protection device (fuses, etc.) incorporated in series within each string. Three or more strings can be connected in parallel if an appropriate and certified over-current protection device is installed in series within each string. And it shall be ensured in the PV system design that the reverse current of any particular string is lower than the module maximum fuse rating at any circumstances.
- Only modules with similar electrical parameters should be connected in the same string to avoid or minimize mismatch effects in arrays.
- To minimize risk in the event of an indirect lightning strike, avoid forming loops with the wiring when designing the system.
- The recommended maximum series fuse rating is stated in the module datasheets.
- Modules should be safely fixed to bear all expected loads, including wind and snow loads.
- Due to thermal linear expansion a minimum distance between the modules is mandatory – at least 10 mm.
- The small drainage holes on the underside of the module must not be blocked.
- The modules cannot stand in backwater or condensation.
- They must be attached flush to the substructure, without tension, deformation or torsion, within the described clamping ranges (see following chapter).
- The clamping has to be systematically, and no clamps are allowed to touch directly front or back glass of the module.

#### 4.4 Optimum Orientation and Tilt

- To maximize the annual yield, please calculate the optimum orientation and tilt for PV modules in that specific installation site. The highest yields are achieved when sunlight shines perpendicularly onto the PV modules.
- DMEGC Solar modules must be installed with a minimum inclination angle of 5° in relation to horizontal. The maximum inclination angle in relation to horizontal is 75°. For the case the preferred inclination angle is off the mentioned range, DMEGC Solar must be contacted before Installation. Otherwise, the warranty will be invalid.
- The modules must be securely attached. To do this, use special elevated installations or assembly kits for use with photovoltaic systems.
- The modules must be adjusted to the same installation angle for the same photovoltaic generator on string

level for standard installation concepts (without further el. devices).

#### 4.5 Avoid Shading

- Modules shall not be permanently shaded (including partial shading, spot shading, even shading or uneven shading) under any circumstance. Permanent shading includes shading of the same cell, cell row, or module portion for extended and repeated periods of time (e.g., more than 200 daylight hours over the warranted service lifetime). Power dissipated in fully or partially shaded cells will result in power loss, reduced yield and can cause localized overheating, which in turn may negatively impact the module service lifetime. Permanent shading may cause accelerated ageing of the encapsulation material and place thermal stress on the bypass diodes. This would void the module's warranty unless properly mitigated through the use of Module Level Power Electronic (MLPE) devices.
- Regular maintenance is required to keep modules clean. Particular measures should be taken to avoid permanent shading from dirt or debris (e.g., plants, bird droppings, etc.).
- Do not install modules directly behind any object (e.g., tree, antenna, etc.) to prevent occurrence of permanent shading.
- Even temporary partial shading will reduce the energy yield. A module can be considered to be unshaded if its entire surface is free from shading all year round, including on the shortest day of the year.

#### 4.6 Reliable Ventilation

- Sufficient clearance - at least 100 mm (3.94 in) between the module bottom side and the surface of the roof or the wall is required to allow cooling air to circulate around the back of the module. This also allows condensation or moisture to dissipate.
- According to UL/IEC 61730, any other specific clearance required for maintaining a system fire rating should prevail. Detailed clearance requirements pertaining to system fire ratings must be provided by your racking supplier.

#### 4.7 Module Wiring

##### Correct Wiring Scheme

- Cable management scheme should be reviewed and approved by the EPC contractor; in particular required cable lengths should be cross-checked considering the specificities of the tracker structure like bearing house gaps. If longer cable or additional jumper cables are requested, please contact DMEGC Solar's sales representative in advance.

- Ensure that the wiring is correct before starting up the system. If the measured open circuit voltage (Voc) and short-circuit current (Isc) differ from the specifications, this indicates that there is a wiring fault.
- When modules have been installed but the system has not been connected to the grid yet, each module string should be kept under open-circuit conditions and proper actions should be taken to avoid dust and moisture penetration inside the connectors.
- In case where a cable connection method not included in the below is used, please confirm the suitable cable length with DMEGC Solar’s sales representative.
- For different DMEGC Solar’s module types, DMEGC Solar offers optional cable lengths to match various system configurations.
- Recommended system cable schemes are shown below:

1. Portrait two rows installation

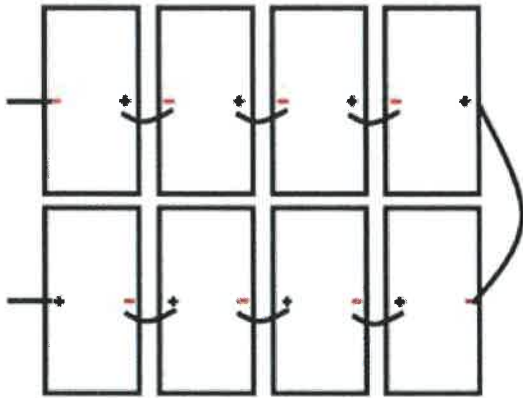

**Note:** Adjacent two modules (up and down) need to be rotated 180 degrees

2. Portrait one row installation

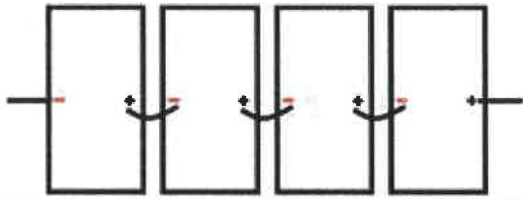

3. Landscape installation

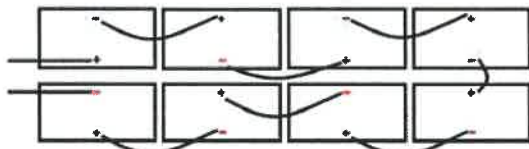

**Note:** Adjacent two modules (left to right) need to be rotated 180 degrees

4. Leapfrog

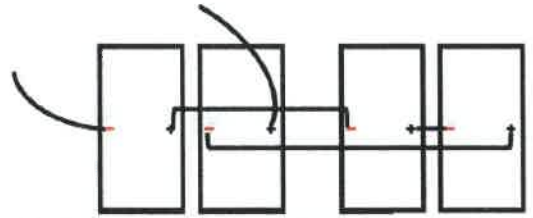

The maximum distance between two adjacent module frames should be within 50 mm (1.96in) for the side with mounting clamps, and 25 mm (0.98in) for the side without mounting clamps, in order to meet the system cable scheme.

**Correct Connection Connectors**

- Make sure that all connections are safe and properly mated. The PV connector should not be subject to stress from the exterior. Connectors should only be used to connect the circuit. They should never be used to turn the circuit on and off.
- Connectors are not waterproof when unmated. When installing modules, connector should be connected to each other as soon as possible or appropriate measures (like using connector endcaps) should be taken to avoid moisture and dust penetrating into the connector.
- Do not connect different connectors (manufacturer and type) together.
- Do not clean or precondition the connectors using lubricants or any unauthorized chemical substances

**Use of Suitable Materials**

- Only use dedicated solar cable and suitable connectors (wiring should be sheathed in a sunlight-resistant conduit or, if exposed, should itself be sunlight-resistant) that meet local fire, building and electrical regulations. Please ensure that all wiring is in perfect electrical and mechanical condition.
- Installers may only use cables listed and labeled as or PV wire, and the cable with a cross section area of at least 4 mm<sup>2</sup> (12 AWG), 90°C wet rated in other areas (i.e. IEC 62930 approved), with proper insulation which is able to withstand the maximum possible system open-circuit voltage.
- Only copper conductor material should be used. Select a suitable conductor gauge to minimize voltage drop and ensure that the conductor ampacity complies with local regulations.

**Cable and Connector Protection**

- Secure the cables to the mounting system using UV-resistant cable ties. Protect exposed cables from damage by taking appropriate precautions (e.g. placing them inside a metallic raceway like EMT conduit). Avoid exposure to direct sunlight.
- A minimum bending radius of 60 mm (2.36 in) is required when securing the junction box cables to the



racking system.

- Protect exposed connectors from weathering damage by taking appropriate precautions. Avoid exposure to direct sunlight.
- Do not place connectors in locations where water could easily accumulate.

#### 4.8 Grounding

- Regional or national requirements must be followed, and they can include an obligation to ground module frames.
- Grounding module frames may also be necessary for preventing lightning strikes/overvoltage.
- Adequate grounding connection must be installed as per the regulations and standards accordingly.
- DMEGC Solar modules provide grounding holes and they are marked on the rear frame side (frame C-side) with a grounding symbol  (IEC 61730-1). All conductive connection junctions must be firmly fixed.
- Grounding connections should be installed by a qualified electrician. Connect module frames together using adequate grounding cables: the use of 4-14 mm<sup>2</sup> (AWG 6-12) copper wire is recommended.
- Do not drill any extra ground holes for convenience as this will void the modules warranty.
- All bolts, nuts, flat washers, lock washers and other relevant hardware should be made of stainless steel, unless otherwise specified.
- DMEGC Solar does not provide grounding hardware.
- The grounding method described below is commended by DMEGC Solar.

##### Grounding by grounding bolt

- Use M8 bolt and washers to bond the ground wire and aluminum frame through the grounding holes (as shown figure 1). The tightening torque is 3-7N.m. All nuts and washers should be made of stainless steel.

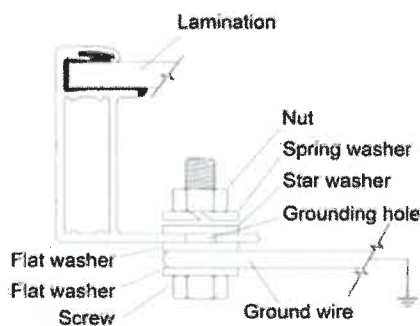

figure 1

##### Grounding by using grounding clamp

- As shown in the *figure2*, the grounding clip assembly consists of a slider, base, and self-captivating thread-cutting screw or 8-32 screw and hex nut. The grounding clip accepts solid uninsulated copper wire sizes 10 or 12 AWG.

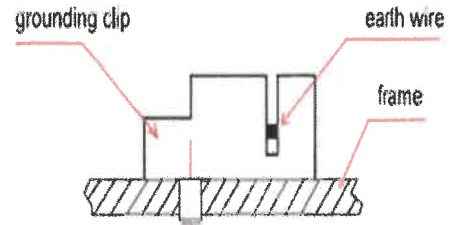

figure 2

##### Addition Third-party Grounding Devices

- DMEGC Solar's Modules can be grounded using third party grounding devices so long as they are certified for grounding modules and the devices are installed according to the manufacturer's specified instructions.

#### 5. Mounting Instructions

The applicable regulations pertaining to work safety, accident prevention and securing the construction site must be observed. Workers and third-party personnel shall wear or install fall arrest equipment. Any third party need to be protected against injuries and damages.

- The mounting design must be certified by a registered professional engineer. The mounting design and procedures must comply with all applicable local codes and requirements from all relevant authorities.
- The module is considered to be in compliance with IEC/UL 61730 and IEC/UL 61215 only when the module is mounted in the manner specified by the mounting instructions included in this installation manual.
- The system designer and installer are responsible for load calculations and for proper design of support structure.
- Any module without a frame (laminated) shall not be considered to comply with the requirements of IEC/UL 61730 unless the module is mounted with hardware that has been tested and evaluated with the module under this standard or by a field inspection certifying that the installed module complies with the requirements of IEC/UL 61730.
- DMEGC Solar does not provide mounting hardware.
- Standard modules can be mounted onto a support structure using one of several approved methods as described below. For information about other installation methods, please contact your local

representative. Failure to use a recognized installation method will void the DMEGC Solar’s warranty.

- Use appropriate corrosion-proof fastening materials. All mounting hardware (bolts, spring washers, flat washers, nuts) should be hot dip galvanized or stainless steel.
- Use a torque wrench for installation.
- Do not drill additional holes or modify the module frame. Doing so will void the warranty.
- Standard modules can be installed in either landscape or portrait orientations. Refer to the detailed instructions for further guidance. Please note that in areas with heavy snowfall (> 2400 Pa) further countermeasures such the use of additional support bars should be considered to avoid snow loads damaging the lowest row of modules.
- The loads described in this manual correspond to test loads. For installations complying with IEC/UL 61215 and IEC/UL 61730, a safety factor of 1.5 should be applied for calculating the equivalent maximum authorized design loads. Project design loads depend on construction, applicable standards, location and local climate. Determination of the design loads is the responsibility of the racking suppliers and/or professional engineers. For detailed information, please follow local structural code or contact your professional structural engineer.

**5.1 Mounting Method: Bolting**

- The mechanical load test with these mounting methods were performed according to IEC/UL 61215.
- Modules should be bolted to supporting structures through the mounting holes in the rear frame flanges only.
- In areas with heavy wind loads, additional mounting points should be used. The system designer and the installer are responsible for correctly calculating the loads and ensuring that the supporting structure meets all the applicable requirements.
- Each module must be securely fastened at a minimum of 4 points on two opposite sides.
- Tightening torques should be 12~16 N•m for M8 coarse thread bolts, depending on bolt class.
- Tightening torques should be 6~9 N•m for M6 coarse thread bolts, depending on bolt class.

- The method and the specifications of the fixing parts are shown in the *figure 3* below:

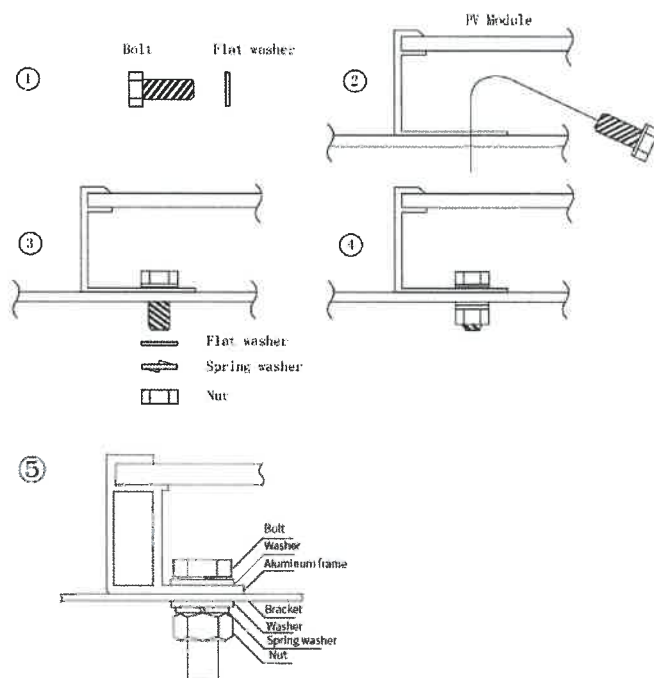

figure 3

Table 2: Specific requirements for parts

Accessories	Model		Material
Bolt	M8	M6	Q235B/SUS304
Washer	2pcs, thickness $\geq 1.5$ mm and outside diameter = 16 mm	2pcs, thickness $\geq 1.5$ mm and outside diameter = 12-18 mm	Q235B/SUS304
Spring Washer	8	6	Q235B/SUS304
Nut	M8	M6	Q235B/SUS304

- Accessories material selection should be based on application environment.
- When using 30 mm height frame module, it is recommended to select L  $\geq 20$  mm length fasteners.

**5.2 Mounting Method: Clamping**

- The mechanical load test with these mounting methods were performed according to IEC/UL 61215.
- Top or bottom clamping methods will vary and are dependent on the mounting structures. Please follow the mounting guidelines recommended by the mounting system supplier.
- Each module must be securely fastened at a minimum of four points on two opposite sides. The clamps should be positioned symmetrically. The clamps should be

positioned according to the authorized position ranges.

- Install and tighten the module clamps to the mounting rails using the torque stated by the mounting hardware manufacturer. M8 bolt and nut are used for this clamping method.
- Tightening torques should be within 18~24 N•m for M8 coarse thread bolts, depending on the bolt class. For the bolt grade, the technical guideline from the fastener suppliers should be followed. Different recommendations from specific clamping hardware suppliers should prevail.
- The system designer and installer are responsible for load calculations and for proper design of support structure.
- DMEGC Solar’s warranty may be void in cases where improper clamps or unsuitable installation methods are found. When installing inter-modules or end-type clamps, please take the following measures into account:
  1. Do not bend the module frame.
  2. Do not touch or cast shadows on the front glass.
  3. Do not damage the surface of the frame (to the exception of the clamps with bonding pins).
  4. Ensure the clamps overlap the module frame by at least 7mm but no more than 12mm.
  5. Overlap in length by at least 50mm.
  6. Ensure the clamp thickness is at least 3 mm.
- Clamp material should be anodized aluminum alloy or stainless steel. The mounting details are shown in the following *figures4* and *figures5*.

figure4

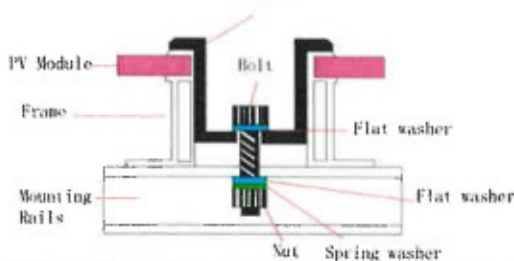
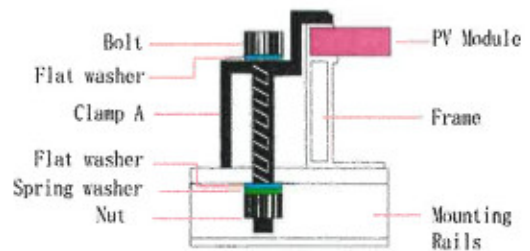

figure 5

**5.3 Assembly variants**

- The high loading capacity applies to severe environment, like storm, big snow, etc. The modules are tested under a maximum positive pressure of 5400 Pa, and negative pressure of 2400 Pa, the modules are designed to meet a maximum positive pressure of 3600 Pa, and negative pressure of 1600 Pa, this design load was then tested with a safety factor of 1.5 times.
- For bifacial double-glass modules, it is recommended that the beam is installed parallel to the long frame to reduce backside shielding.
- Required safety factors should be in line with EN 1991-x-x standard series. If not applicable the safety factor 1.5 - as indicated in the valid IEC/UL 61215-x for design loads - must be used.
- The installation instructions must be followed according to this DMEGC installation manual.
- DMEGC will not be responsible for any solar module defects caused by operation, design and material of the installation. The defects are including but not limiting to glass breakage, EL cracks and other potential issues.
- Note: \*Loads according to IEC 61215-2:2016; Design load = Test load / safety factor 1.5



**M10-66/72/78 & M10T-66/72/78 (Mono-facial single glass & Bifacial-dual glass)**

Installation method	Outer four holes, mounting rails parallel the long frame	Outer four holes, mounting rails cross the long frame
Bolt installation		
Loading capacity	Test load: positive 2400Pa, negative 2400Pa Design load: positive 1600Pa, negative 1600Pa	Test load: positive 5400Pa, negative 2400Pa Design load: positive 3600Pa, negative 1600Pa

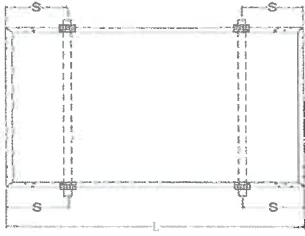
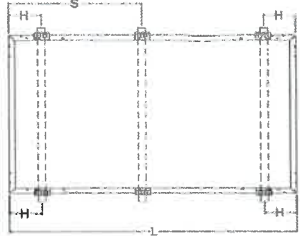
Installation method	Mounting by four clamps, mounting rails cross the long frame	Mounting by six clamps, mounting rails cross the long frame
Clamp installation		
Clamp position	$(1/5L-50) < S < (1/5L+50)$	$(1/2L-80) < S < (1/2L-30); (1/6L-50) < H < (1/6L+50)$
Loading capacity	Test load: positive 5400Pa, negative 2400Pa Design load: positive 3600Pa, negative 1600Pa	Test load: positive 5400Pa, negative 3600Pa Design load: positive 3600Pa, negative 2400Pa

**G12RT-66 ((Mono-facial single glass & Bifacial-dual glass))**

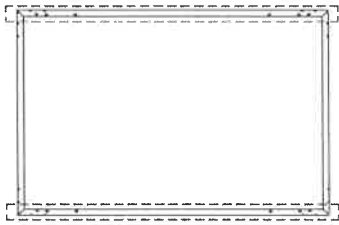
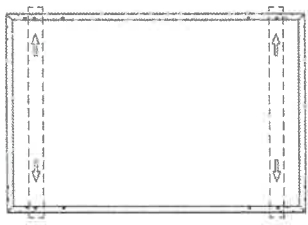
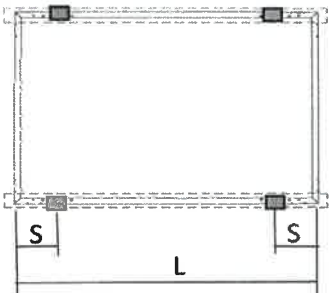
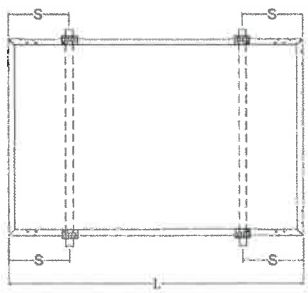

Installation method	Outer four holes (1400mm holes) mounting rails parallel the long frame	Outer four holes (1400mm holes) mounting rails cross the long frame
Bolt installation		
Loading capacity	Test load: positive 2400Pa, negative 2400Pa Design load: positive 1600Pa, negative 1600Pa	Test load: positive 5400Pa, negative 2400Pa Design load: positive 3600Pa, negative 1600Pa
Installation method	4 clamps, mounting rails parallel the long frame	4 clamps, mounting rails cross the long frame
Clamp installation		
Clamp position	$450\text{mm} \leq S \leq 550\text{mm}$	$450\text{mm} \leq S \leq 550\text{mm}$
Loading capacity	Test load: positive 2400Pa, negative 2400Pa Design load: positive 1600Pa, negative 1600Pa	Test load: positive 5400Pa, negative 2400Pa Design load: positive 3600Pa, negative 1600Pa

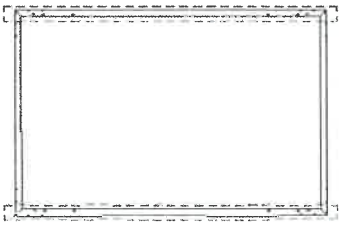
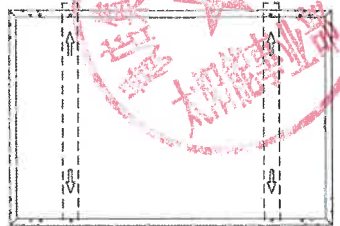

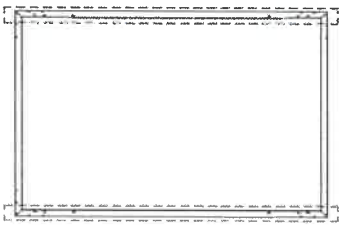
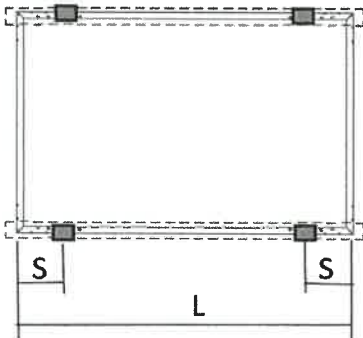
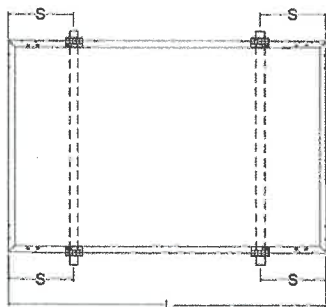
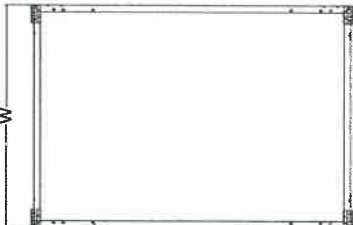
**M10RT-54 ((Mono-facial single glass & Bifacial-dual glass))**

Installation method	Inner four holes (1150mm holes) mounting rails parallel the long frame	Inner four holes (1150mm holes) mounting rails cross the long frame
Bolt installation		

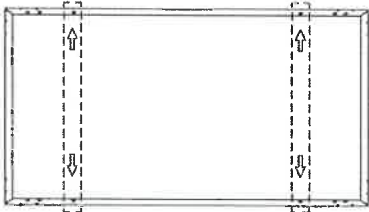
Loading capacity	Test load: positive 2400Pa, negative 2400Pa Design load: positive 1600Pa, negative 1600Pa	Test load: positive 5400Pa, negative 2400Pa Design load: positive 3600Pa, negative 1600Pa
Installation method	<b>Outer four holes (1400mm holes) mounting rails parallel the long frame</b>	
Bolt installation		
Loading capacity	Test load: positive 2400Pa, negative 2400Pa Design load: positive 1600Pa, negative 1600Pa	
Installation method	<b>4 clamps, mounting rails parallel the long frame</b>	<b>4 clamps, mounting rails cross the long frame</b>
Clamp installation		
Clamp position	$390\text{mm} \leq S \leq 490\text{mm}$	$390\text{mm} \leq S \leq 490\text{mm}$
Loading capacity	Test load: positive 2400Pa, negative 2400Pa Design load: positive 1600Pa, negative 1600Pa	Test load: positive 5400Pa, negative 2400Pa Design load: positive 3600Pa, negative 1600Pa
Installation method	<b>4 point corner clamping short side</b>	
Clamp installation		
Clamp position	Starting directly at the outer edge of the module on the short frame side in the length of the clamp	
Loading capacity	Test load: positive 1600Pa, negative 1600Pa Design load: positive 1067Pa, negative 1067Pa	

**M10-54 & M10T-54 (Mono-facial single glass & Bifacial-dual glass)**

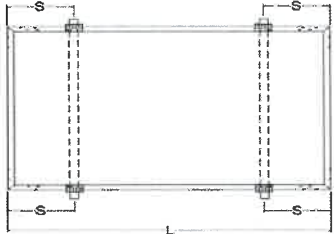
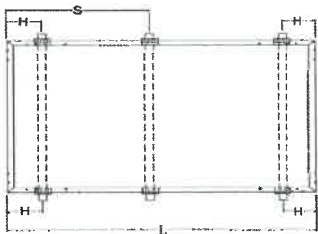
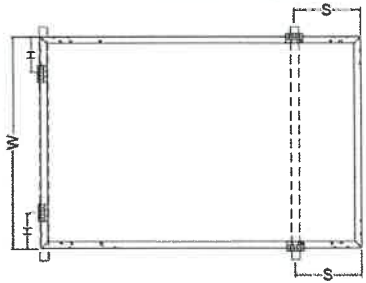
Installation method	<b>Inner four holes (1150mm), mounting rails cross the long frame</b>	Installation method	<b>Clamp mounting on short side of frame and rails perpendicular to the long side frame</b>
Bolt installation		Clamp installation	

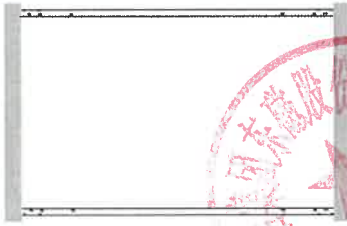
		Clamp position	$0 < H < 1/4W$
Loading capacity	Test load: positive 5400Pa, negative 2400Pa Design load: positive 3600Pa, negative 1600Pa	Loading capacity	Test load: positive 2400Pa, negative 1600Pa Design load: positive 1600Pa, negative 1067Pa
Installation method	<b>Mounting by four clamps, mounting rails cross the long frame</b>	<b>Mounting by six clamps, mounting rails cross the long frame</b>	
Clamp installation			
Clamp position	$(1/5L-50) < S < (1/5L+50)$	$(1/2L-80) < S < (1/2L-30); (1/6L-50) < H < (1/6L+50)$	
Loading capacity	Test load: positive 5400Pa, negative 2400Pa Design load: positive 3600Pa, negative 1600Pa	Test load: positive 5400Pa, negative 3600Pa Design load: positive 3600Pa, negative 2400Pa	
Installation method	<b>Two clamps on the long side and two clamps on the short side of frame. Rails run perpendicular to the long side frame.</b>	<b>4 point corner clamping short side</b>	
Clamp installation			
Clamp position	$(1/4L-50) < S < (1/4L+50),$ $(1/4W-50) < H < (1/4W+50)$	Starting directly at the outer edge of the module on the short frame side in the length of the clamp	
Loading capacity	Test load: positive 2400Pa, negative 2400Pa Design load: positive 1600Pa, negative 1600Pa	Test load: positive 1600Pa, negative 1600Pa Design load: positive 1067Pa, negative 1067Pa <small>Note: Increase to 1800 / 1800 Pa test load with DMEGC stronger frame for M10T-54/B54 possible please contact DMEGC for material selection for DMEGC stronger frame</small>	
Installation method	<b>Long side in-rail installation</b>	<b>Short side in-rail installation</b>	
In-rail installation			
Loading capacity	Test load: positive 5400Pa, negative 2400Pa Design load: positive 3600Pa, negative 1600Pa	Test load: positive 2400Pa, negative 1600Pa Design load: positive 1600Pa, negative 1067Pa	

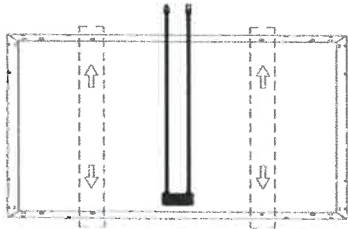
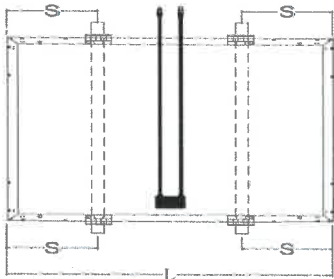
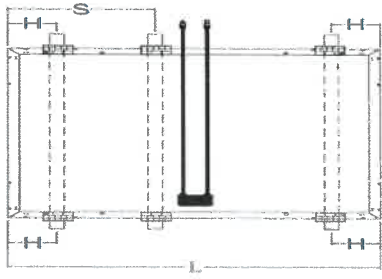

**M10-30HSW/HBW and M10-B30HSW/HBW**

Installation method	<b>4 bolts at the long frame (30H inner holes)</b>
---------------------	--

Bolt installation		
Loading capacity	Test load: positive 5400Pa, negative 2400Pa Design load: positive 3600Pa, negative 1600Pa	
Installation method	<b>4 clamps at the long frame</b>	<b>6 clamps at the long frame</b>
Clamp installation		
Clamp position	$(1/4L-50) < S < (1/4L+50)$	$(1/2L-120) < S < (1/2L-70); (1/8L-50) < H < (1/8L+50)$
Loading capacity	Test load: positive 5400Pa, negative 2400Pa Design load: positive 3600Pa, negative 1600Pa	Test load: positive 5400Pa, negative 3600Pa Design load: positive 3600Pa, negative 2400Pa

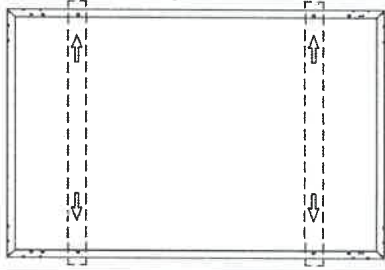
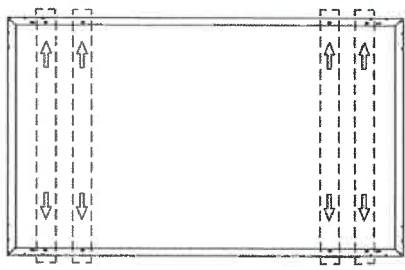
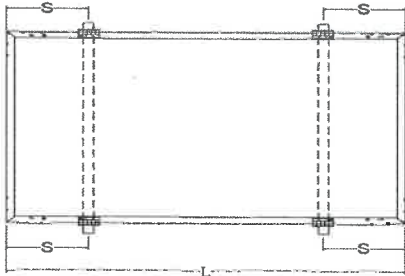
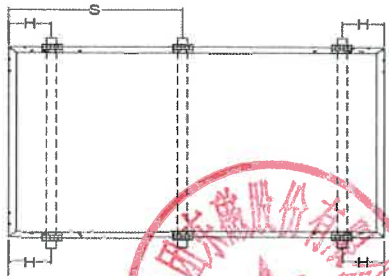
**M2、P1、G1、M6-72/72H (Mono-facial single glass & Bifacial-dual glass)**

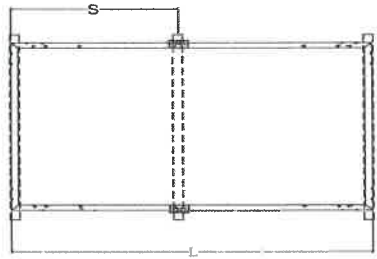

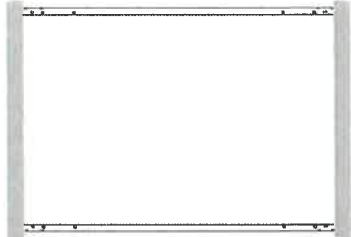
Installation method	<b>Inner four holes, mounting rails cross the long frame</b>	<b>8 bolts at the long frame, mounting rails cross the long frame</b>
Bolt installation		
Loading capacity	Test load: positive 3600Pa, negative 2400Pa Design load: positive 2400Pa, negative 1600Pa	Test load: positive 5400Pa, negative 3600Pa Design load: positive 3600Pa, negative 2400Pa
Installation method	<b>Mounting by four clamps, mounting rails cross the long frame</b>	<b>Mounting by six clamps, mounting rails cross the long frame</b>
Clamp installation		
Clamp position	$(1/4L-50) < S < (1/4L+50)$	$(1/2L-80) < S < (1/2L-30); (1/6L-50) < H < (1/6L+50)$
Loading capacity	Test load: positive 5400Pa, negative 2400Pa Design load: positive 3600Pa, negative 1600Pa	Test load: positive 5400Pa, negative 3600Pa Design load: positive 3600Pa, negative 2400Pa
Installation method	<b>Clamp mounting on short side of frame and rails perpendicular to the long side frame.</b>	<b>Short side in-rail installation +long side reinforce with clamps</b>

Clamp installation		
Clamp position	$0 < H < 1/4W$	$(1/2L-80) < S < (1/2L-30)$
Loading capacity	Test load: positive 1600Pa, negative 1600Pa Design load: positive 1067Pa, negative 1067Pa	Test load: positive 5400Pa, negative 2400Pa Design load: positive 3600Pa, negative 1600Pa
Installation method	<b>Long side in-rail installation</b>	<b>Short side in-rail installation</b>
In-rail installation		
Loading capacity	Test load: positive 5400Pa, negative 2400Pa Design load: positive 3600Pa, negative 1600Pa	Test load: positive 1600Pa, negative 1600Pa Design load: positive 1067Pa, negative 1067Pa

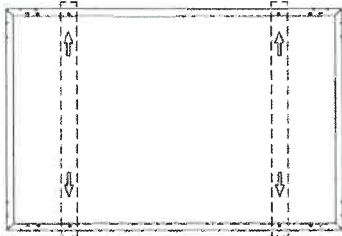
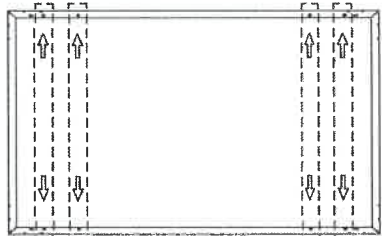
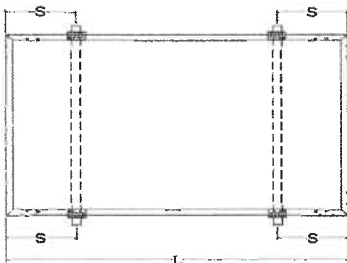
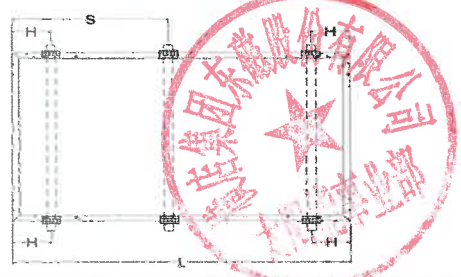
**M2、P1、G1、M6-60/60H (Mono-facial single glass & Bifacial-dual glass)**

Installation method	<b>Inner four holes, mounting rails cross the long frame</b>	<b>8 bolts at the long frame, mounting rails cross the long frame</b>
Bolt installation		
Loading capacity	Test load: positive 5400Pa, negative 2400Pa Design load: positive 3600Pa, negative 1600Pa	Test load: positive 5400Pa, negative 3600Pa Design load: positive 3600Pa, negative 2400Pa
Installation method	<b>Mounting by four clamps, mounting rails cross the long frame</b>	<b>Mounting by six clamps, mounting rails cross the long frame</b>
Clamp installation		
Clamp position	$(1/4L-50) < S < (1/4L+50)$	$(1/2L-80) < S < (1/2L-30); (1/6L-50) < H < (1/6L+50)$
Loading capacity	Test load: positive 5400Pa, negative 2400Pa Design load: positive 3600Pa, negative 1600Pa	Test load: positive 5400Pa, negative 3600Pa Design load: positive 3600Pa, negative 2400Pa
Installation method	<b>Clamp mounting on short side of frame and rails perpendicular to the long side frame.</b>	<b>Short side in-rail installation + long side reinforce with clamps</b>

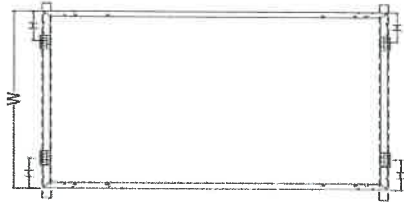
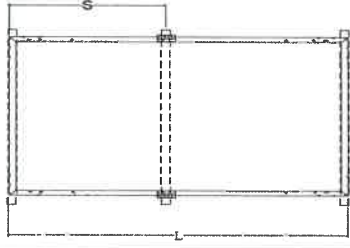

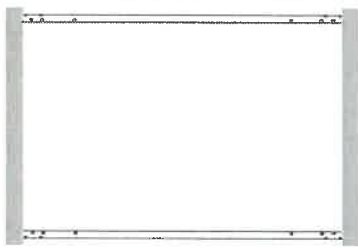
Clamp installation		
Clamp position	$0 < H < 1/4W$	$(1/2L-80) < S < (1/2L-30)$
Loading capacity	Test load: positive 2400Pa, negative 1600Pa Design load: positive 1600Pa, negative 1067Pa	Test load: positive 5400Pa, negative 2400Pa Design load: positive 3600Pa, negative 1600Pa
Installation method	<b>Long side in-rail installation</b>	<b>Short side in-rail installation</b>
In-rail installation		
Loading capacity	Test load: positive 5400Pa, negative 2400Pa Design load: positive 3600Pa, negative 1600Pa	Test load: positive 2400Pa, negative 1600Pa Design load: positive 1600Pa, negative 1067Pa

DMEGC Solar modules can be used with mainstream mounting systems in the PV industry.

In the following table some references are further listed. If other mounting systems are needed, please consult DMEGC Solar technical customer service.

Mounting manufacturer	Mounting components	DMEGC module type	Test load
NEXTracker NX Horizon (1P)	Short Rail V2.4 + Reinforcement (400 mm holes position)	M10T-B72HSW 30mm frame height	positive 1800Pa, negative 1800Pa
Zimmermann PV-Tracker(1P)	Module holder bifacial curved with hooks (400 mm holes)	M10T-B72HSW 30mm frame height	positive 1800Pa, negative 1800Pa
CWF	Vario Slide-in Alu	3-piece modules vertical installation for M10T-B72HSW/M10-B72HSW 30mm frame height	positive 2400Pa, negative 2400Pa  If the supporting rail will be expanded to cover the entire module length an increase for the pressure load can be provided to positive 3600Pa, negative 2400Pa
		6 modules horizontally installation for M10T-B54HSW/M10-B54HSW 30mm frame height	positive 2400Pa, negative 1600Pa

## 6. Maintenance

- Do not make modifications to any component of the PV module (diode, junction box, connectors or others).
- Regular maintenance is required to keep modules clear of snow, bird droppings, seeds, pollen, leaves, branches, dirt spots, and dust.
- Modules with sufficient tilt (at least 15°), generally may

not require cleaning (rain will have a self-cleaning effect). If the module has become soiled, wash with water and a non-abrasive cleaning implement (sponge) during the cool part of the day. Do not scrape or rub dry dirt away, as this may cause micro scratches.

- Snow should be removed using a soft brush.
- Periodically inspect the system to check the integrity of all wiring and supports.

- To protect against electric shock or injury, electrical or mechanical inspections and maintenance should be performed by qualified personnel only.

## 7. Module Cleaning Guidelines

- This manual covers the requirements for the cleaning procedure of PV modules of DMEGC Solar. The purpose of these cleaning guidelines is to provide general information for cleaning DMEGC Solar's modules. System users and professional installers should read these guidelines carefully and strictly follow these instructions.
- Failure to follow these instructions may result in death, injury or damage to the photovoltaic modules. Damages induced by inappropriate cleaning procedures will void DMEGC Solar's warranty.



### Safety Warning

- Cleaning activities create risk of damaging the modules and array components, as well as increasing the potential electric shock hazard.
- Cracked or broken modules represent an electric shock hazard due to leakage currents, and the risk of shock is increased when modules are wet. Before cleaning, thoroughly inspect modules for cracks, damage, and loose connections.
- The voltage and current present in an array during daylight hours are sufficient to cause a lethal electrical shock.
- Ensure that the circuit is disconnected before starting the cleaning procedure as contact with leakage of electrically active parts can result in injury.
- Ensure that the array has been disconnected to other active components (such as inverter or combiner boxes) before starting with the cleaning.
- Wear suitable protection (clothes, insulated gloves, etc.).
- Do not immerse the module, partially or totally, in water or any other cleaning solution.
- Rear side cleaning of the modules is not required. If cleaning the rear of a module is desired, care should be taken to ensure there is no damage caused to the backsheet by simply clearing the contaminant by hand or with a soft sponge.

### Handing Notice

- Use a proper cleaning solution and suitable cleaning equipment.
- Do not use abrasive or electric cleaners on the module.

- Particular attention should be taken to avoid the module backsheet or frame to come in contact with sharp objects, as scratches may directly affect product safety.
- Do not use abrasive cleaners, de-greasers or any unauthorized chemical substance (e.g. oil, lubricant, pesticide, etc.) on the module.
- Do not use cleaning corrosive solutions containing hydrofluoric acid, alkali, acetone, or industrial alcohol. Only substances explicitly approved by DMEGC Solar are allowed to be used for cleaning modules.
- For cleaning methods using rotating brush, please consult with DMEGC Solar's technical support before using.
- Dirt must never be scraped or rubbed away when dry, as this will cause micro-scratches on the glass surface.

### OPERATION PREPARATION

- Noticeable dirt must be rubbed away by gentle cleaning implement (soft cloth, sponge or brush with soft bristles).
- Ensure that brushes or agitating tools are not abrasive to glass, EPDM, silicone, aluminum, or steel.
- Conduct the cleaning activities avoiding the hottest hours of the day, in order to avoid thermal stress on the module.

### CLEANING METHODS

#### Method A: Compressed Air

DMEGC Solar recommends cleaning the soft dirt (like dust) on modules just with air pressure. This technique can be applied as long as the method is efficient enough considering the existing conditions.

#### Method B: Wet cleaning

- If excessive soiling is present on the module surface, a non-conductive brush, sponge, or other mild agitating method may be used with caution.
- Ensure that any brushes or agitating tools are constructed with non-conductive materials to minimize risk of electric shock and that they are not abrasive to the glass or the aluminum frame.
- If grease is present, an environmental-friendly cleaning agent may be used with caution.
- DMEGC Solar recommends the following to be used:
  1. Water with low mineral content
  2. Near neutral pH water
  3. The maximum water pressure recommended is 4 MPa (40 bar)

**NOTICE**

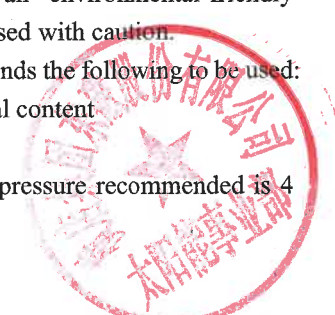

## 8. Disposal



Faulty or old modules must be disposed of correctly. They must be disposed according to the valid disposal regulations for electronic scrap.

### NOTICE

Intended use

PV modules are installed in the following special applications:		notes
Building attached PV (BAPV)	<input checked="" type="checkbox"/> yes	
	<input type="checkbox"/> no	
Building integrated PV (BIPV)	<input type="checkbox"/> yes	
	<input checked="" type="checkbox"/> no	
Applications in areas where snow and / or wind load exceeding loads as tested in IEC/UL 61730-2 are expected	<input type="checkbox"/> yes	
	<input checked="" type="checkbox"/> no	
Module-applied electronics	<input type="checkbox"/> yes	
	<input checked="" type="checkbox"/> no	
Areas with high salt exposure	<input checked="" type="checkbox"/> yes	
	<input type="checkbox"/> no	
Ammonia test IEC 62716 Ammonia Resistance evidence available on request	<input checked="" type="checkbox"/> yes	
	<input type="checkbox"/> no	
Salt mist	<input checked="" type="checkbox"/> yes	Level 6
	<input type="checkbox"/> no	
Dust and sand	<input checked="" type="checkbox"/> yes	LC1
	<input type="checkbox"/> no	



**Annex**

The following module models adopt the testing standards:

IEC 61215-1:2016, IEC61215-1-1:2016, IEC61215-2:2016, IEC61730-1:2016 and IEC61730-2:2016.

Glass/Foil Modules	Double Glass Modules
DMXXXM10-54HSW/HBW/HBB(-V)	DMXXXM10-G/B54HSW/HBW/HBB/HBT/HST
DMXXXM10-66HSW/HBW/HBB(-V)	DMXXXM10-G/B66HSW/HBW/HBB/HBT/HST
DMXXXM10-72HSW/HBW/HBB(-V)	DMXXXM10-G/B72HSW/HBW/HBB/HBT/HST
DMXXXM10-78HSW/HBW(-V)	DMXXXM10-G/B78HSW/HBW/HBB/HBT/HST
DMXXXM6-60HSW/HBW/HBB(-V)	DMXXXM6-G/B60HSW//HBW/HBB/HBT/HST
DMXXXM6-72HSW/HBW/HBB(-V)	DMXXXM6-G/B72HSW/HBW/HBB/HBT/HST
DMXXXG1-60HSW/HBW/HBB(-V)	DMXXXG1-G/B60HSW/HBW/HBB/HBT/HST
DMXXXG1-72HSW/HBW/HBB(-V)	DMXXXG1-G/B72HSW/HBW/HBB/HBT/HST
DMXXXG1-60SW/BW/BB(-V)	DMXXXG1-G/B60SW/BW/BB/BT/ST
DMXXXG1-72SW/BW/BB(-V)	DMXXXG1-G/B72SW/BW/BB/BT/ST
DMXXXM2-60HSW/HBW/HBB(-V)	DMXXXM2-G/B60HSW/HBW/HBB/HBT/HST
DMXXXM2-72HSW/HBW/HBB(-V)	DMXXXM2-G/B72HSW/HBW/HBB/HBT/HST
DMXXXM2-60SW/BW/BB(-V)	DMXXXM2-G/B60SW/BW/BB/BT
DMXXXM2-72SW/BW/BB(-V)	DMXXXM2-G/B72SW/BW/BB/BT
DMXXXP1-60HSW/BW(-V)	DMXXXM10-B30HSW/HBW
DMXXXP1-72HSW/BW(-V)	
DMXXXP1-60SW/BW(-V)	
DMXXXP1-72SW/BW(-V)	
DMXXXM10-30HSW/HBW(-V)	

The following module models adopt the test standards:

IEC 61215-1:2021, IEC61215-1-1:2021, IEC61215-2:2021, IEC61730-1:2016 and IEC61730-2:2016.

and be gradually upgraded to IEC61730-1:2023 and IEC 61730-2:2023 since November 2023.

Glass/Foil Modules	Double Glass Modules
DMXXXM10T-54HSW/HBW/HBB(-V)	DMXXXM10T-B54HSW/HBW/HBB/HBT/HST
DMXXXM10T-66HSW/HBW/HBB(-V)	DMXXXM10T-B66HSW/HBW/HBB/HBT/HST
DMXXXM10T-72HSW/HBW/HBB(-V)	DMXXXM10T-B72HSW/HBW/HBB/HBT/HST
DMXXXM10T-78HSW/HBW(-V)	DMXXXM10T-B78HSW/HBW/HBB/HBT/HST
DMXXXM10RT-54HSW/HBW/HBB(-V)	DMXXXM10RT-B54HSW/HBW/HBB/HST/HBT
DMXXXG12RT-66HSW/HBW(-V)	DMXXXG12RT-B66HSW/HBW/HBB/HST/HBT

